

sapa:

buildingsystem

ARCHITECTURAL ALUMINIUM SOLUTIONS

# SAPA DØR 2050

Uisolert dør til innvendige løsninger



# Sapa Dør 2050

Dørsystemet er basert på uisolerte aluminiumprofiler med en profildybde på 50 mm. Finnes med integrert eller utskiftbart anslag på karmsiden. Den ytre glasslisten er integrert i profilen for asymmetrisk plassert glass. 2050 kan også utføres med symmetrisk plassert glass med tre ulike designglasslister. Det finnes dørbladprofiler for smal- og modullås, og for klemfri bakkant. Dørene kan enkelt tilsluttes vårt system for glassvegger og glasspartier, 3050.

2050 anbefaler vi til innvendige løsninger. Profilens høyde og utseende er som for 2074 og 2086.

Dør 2050 designeksempel

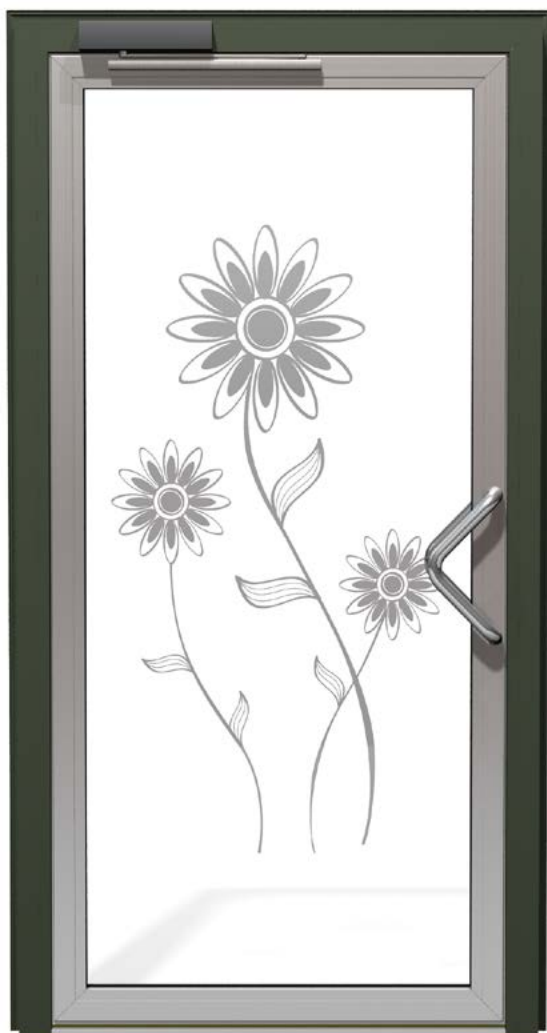

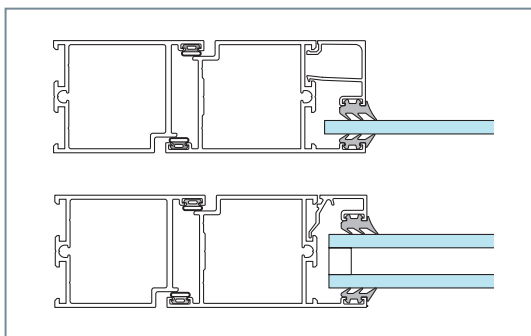

Dør 2050	Integrert glasslist	Designlist
Utførelse	Enkle dører, pardører, møtegående dører, folde- og skyvedører med eller uten side- og overlys	Enkle dører, pardører, møtegående dører med eller uten side- og overlys
Designvalg	Smal- og modulprofil Integrert glasslist	Tre ulike designglasslister
Fals for glass og fyllinger	3-33 mm	5-10 mm
Branssikring, klasse	E 30	
Barnesikring	Kan fås med klemfri bakkant	
Vedlikehold	Utskiftbart anslag på karmside. Kan fås med forsterket anslagsprofil. Gjør det enklere å reparere.	



Prinsippdetaljer Sapa 2050

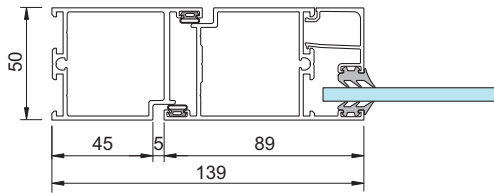
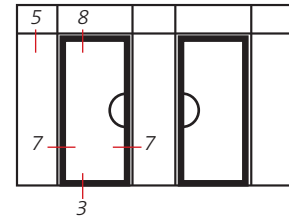
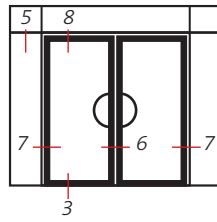
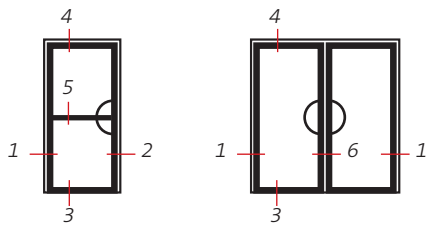

1, 2 - Dør med smalprofil

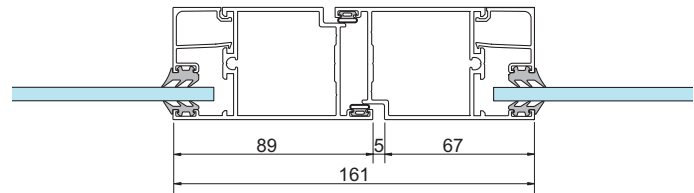

6 - Pardører, smalprofil

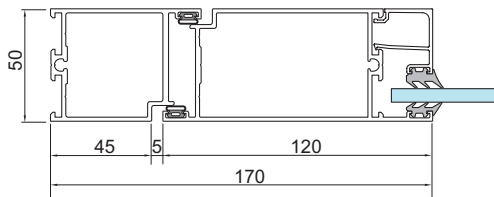

1, 2 - Dør med modulprofil

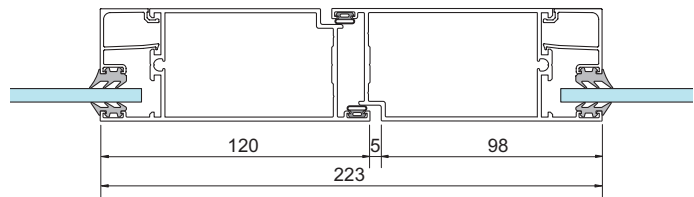

6 - Pardører, modulprofil

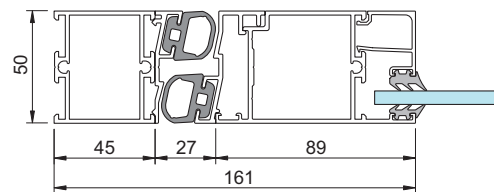

1 - Dør med klemfri bakkant, gummilister

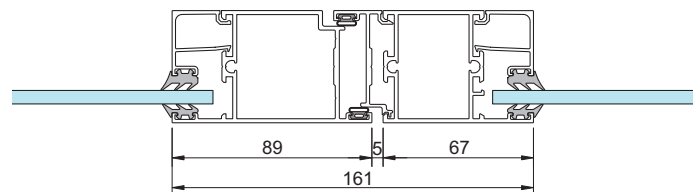

7 - Dør med smalprofil og sidelys

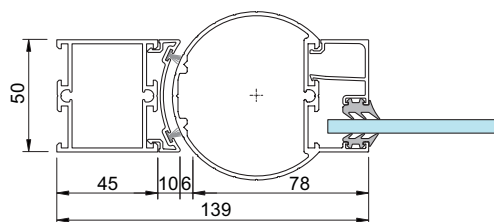

1 - Dør med klemfri bakkant, avrundet aluminiumprofil

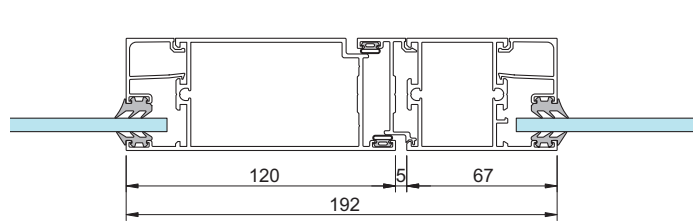

7 - Dør med modulprofil og sidelys

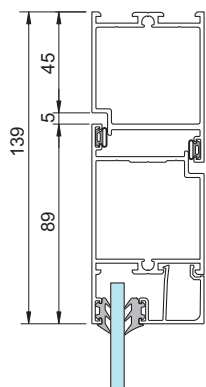

4 - OK dør med karm

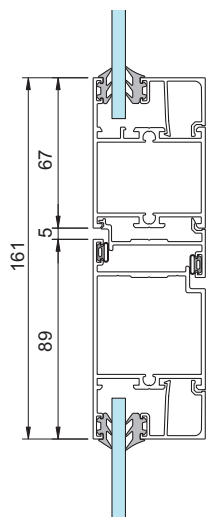

8 - OK dør med overlys

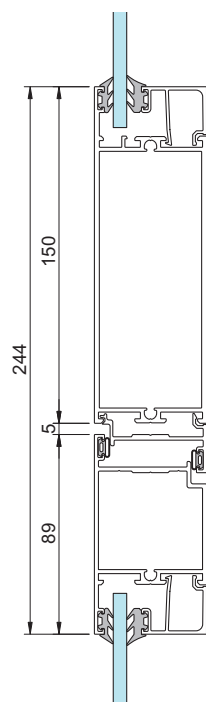

8 - OK dør med overlys og profil for slagdørsautomatikk

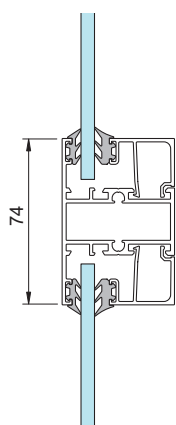

5 - Sprosse

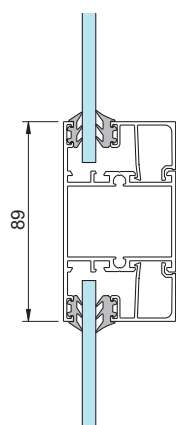

5 - Sprosse

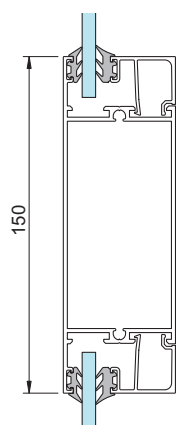

5 - Sprosse

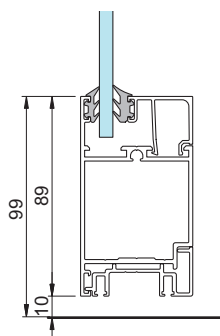

3 - Dør uten terskel

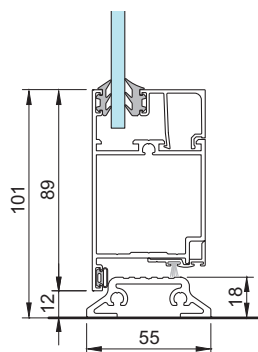

3 - Dør med anslagstetting mot faset terskel

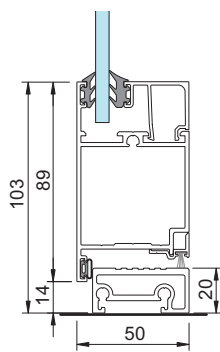

3 - Dør med anslagstetting mot terskel

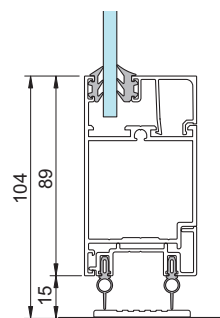

3 - Dør med slepetetting

Prinsippdetaljer Sapa 2050 Designlister

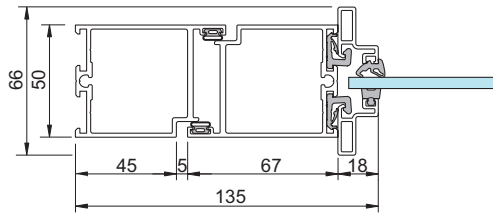
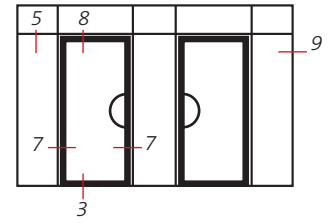
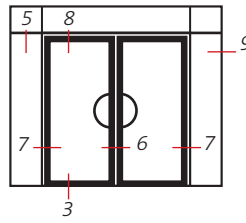
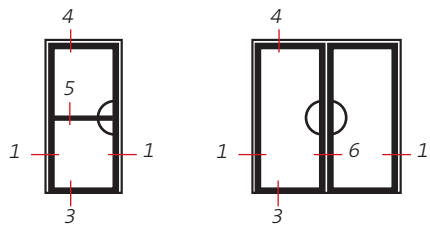

1 - Dør med L-formet glasslist.

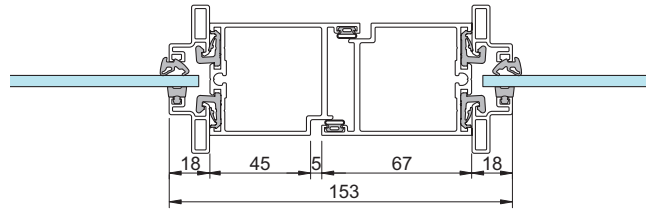

6 - Par dører

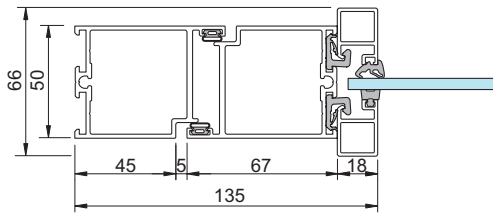

1 - Dør med rektangulær glasslist

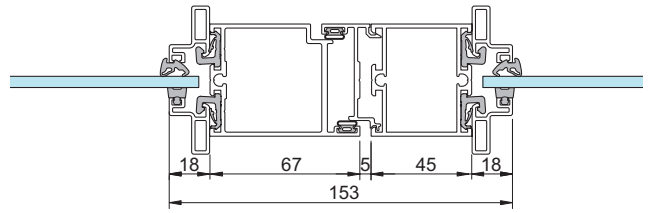

7 - Dør med sidelys

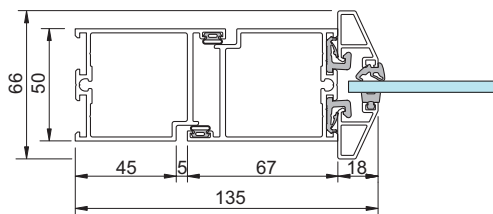

1 - Dør med faset glasslist

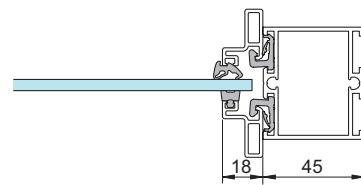

9 - Karmprofil

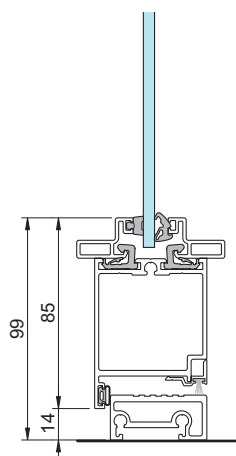

3 - Alternative tilslutninger  
UK dør, se forrige side

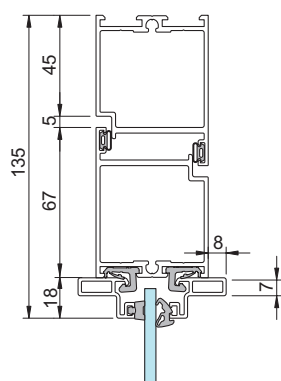

4 - OK dør med karm

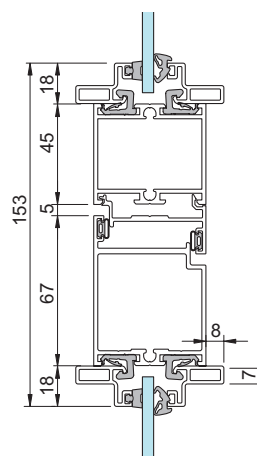

8 - OK dør med overlys

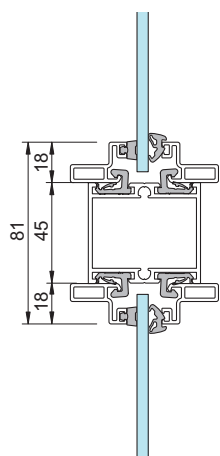

5 - Sprosse

Fri lysåpning Sapa 2050

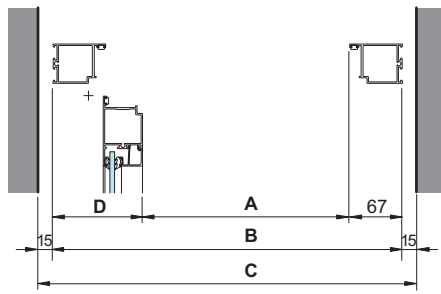

Anslagsdør

- A= Fri åpning
- B= Karmyttermål
- C= Veggåpning

Anslagsdør  
Med universalhengsle:  
D= 115 mm  
Med bladhengsle:  
D= 109 mm

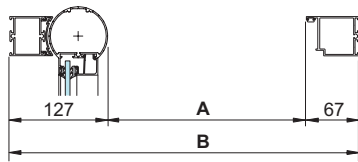

Dør med klemfri bakkant

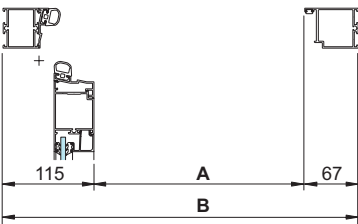

Dør med klemfri bakkant

Glass, asymmetrisk plassert Sapa 2050

Glasstykkelse 3-33 mm

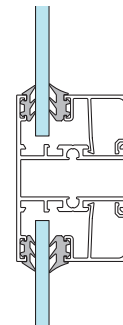

Glass, symmetrisk plassert Sapa 2050

Glasstykkelse 5-10 mm

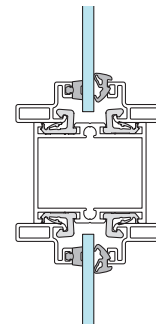

Innfestingsalternativer Sapa 2050

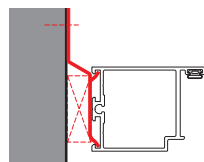
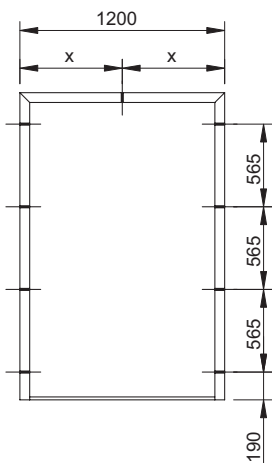

Karminnfesting med vrideankere.

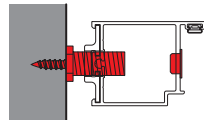

Karminnfesting med justerbar karmhylse

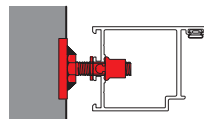

Karminnfesting med bolt og sveiseplate

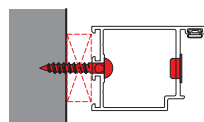

Karminnfesting med skruer

Innfesting av dørparti skal skje i en stabil og tilpasset veggkonstruksjon.  
Veggtypen bestemmer valg av monteringsmetode.  
Antall innfestingspunkter iht. SS 81 73 27.

Fylling Sapa 2050

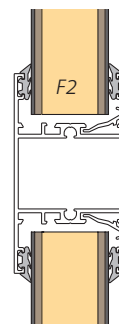

Fylling F1  
1,5 mm aluminiumplate  
maks. 30 mm isolering  
1,5 mm aluminiumplate

Fylling F2  
1,5 mm aluminiumplate  
4,8 mm board  
maks. 20 mm isolering  
4,8 mm board  
1,5 mm aluminiumplate

Fylling F3  
1,5 mm aluminiumplate  
10 mm bygningsplate  
maks. 20 mm isolering  
1,5 mm aluminiumplate

Les mer i kapitlet Glasspartier.



# SAPA DØR 2050

## Beslag

Design av helheten. Med systemløsninger følger flere valgmuligheter. Her presenteres et utvalg.



2086/2074/2050 smalprofil, utside.



2086/2074/2050 modulprofil, utside.

### Håndtak og dørhåndtak. Lås. Hengsler



**Halvsirkelformet håndtak**  
med skjulte innfestinger.  
Høyde 300 mm, Ø 30 mm.  
Aluminium eller rustfritt stål.



**Trekantformet håndtak**  
med skjulte innfestinger.  
Høyde 300 mm, Ø 30 mm.  
Aluminium.



**Rektangulært håndtak**  
med skjulte innfestinger.  
Høyde 300 mm, Ø 30 mm.



**Dørhåndtak til innerdør**  
Dørhåndtak, vrider, rosett og  
sylinderrosett med  
modulprofil.  
Bredde 137 mm, Ø 21 mm.



**Universalhengsler.**



**Bladhengsler.**

### Systemleverandør

SAPA BUILDING SYSTEMS | Kjeller Vest 6, 2007 Kjeller  
T 63 89 21 00  
system.no@sapagroup.com | www.sapabuildingsystem.no

### Autorisert produsent